

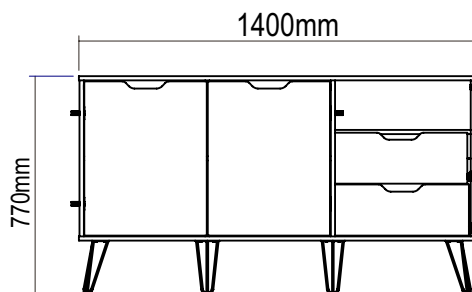

Buffet Estocolmo

Rack Estocolmo / Estante Estocolmo

Versão 1.0 / Versión 1.0 / 1.0 Version

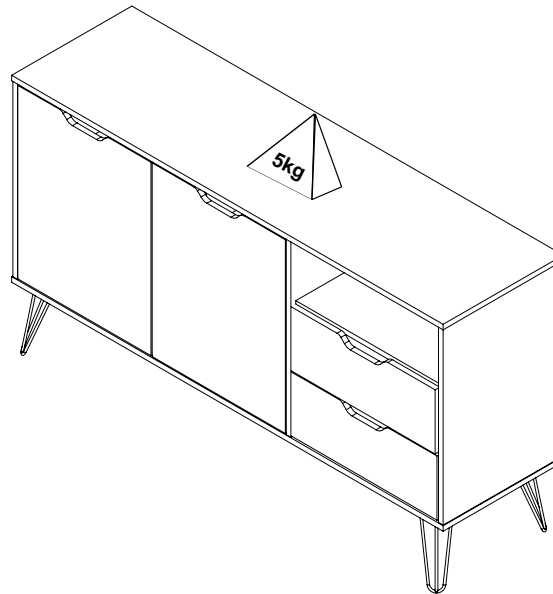

frente/frente/front

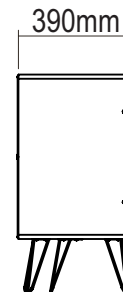

lateral/lado/side

Conservação e Limpeza - Conservación y Limpieza - Conservation and Cleaning

Não expor o produto ao sol, altas temperaturas e umidade. Não arrastar objetos sobre a superfície do móvel (ex.: TV, DVD, aparelho de som, objetos decorativos...) e manter em local seco e arejado. Para a limpeza, utilizar um pano seco e macio. Não é necessário o uso de materiais abrasivos ou álcool.

No exponga el producto a la luz solar, las altas temperaturas y la humedad. No arrastre los objetos a través de la superficie de la unidad (por ejemplo, TV, DVD, equipo de música, objetos de decoración ...) Mantener en un lugar fresco y seco.

Para la limpieza, utilizar un paño seco y suave. El uso de materiales abrasivos o del alcohol no es necesario.

Do not expose the product to sunlight, high temperatures and humidity. Do not drag objects across the surface of the unit (TV, DVD, stereo, decorative objects ...) keep it in a cool dry place. For cleaning, use a dry and soft cloth. Do not use abrasive materials or alcohol.

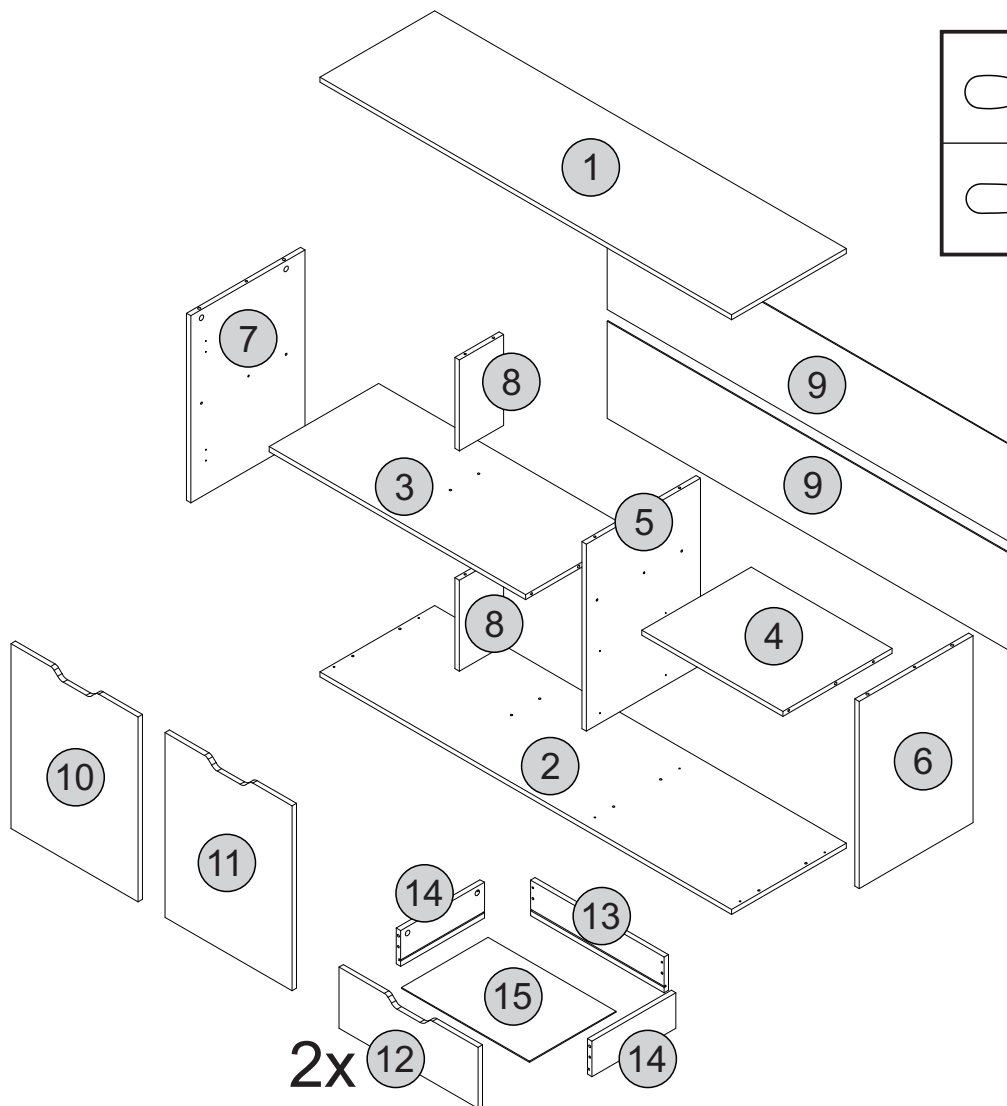



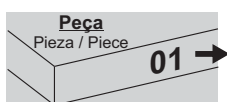



| Descrição | Descripción | Description | Qty |
|-------------------------------------|----------------------|------------------|-----|
| 1-Tampo (1400x390x15mm) | 1-Tapa | 1-Top | 1 |
| 2-Base (1400x390x15mm) | 2-Base | 2-Base | 1 |
| 3-Prateleira Grande (872x372x15mm) | 3-Big Anaquel | 3-Shelf | 1 |
| 4-Prateleira Pequena (479x372x15mm) | 4-Small Anaquel | 4-Right Side | 1 |
| 5-Divisão (551x388x15mm) | 5-División | 5-Division | 2 |
| 6-Lateral Direita (551x388x15mm) | 6-Lado Derecho | 6-Right Side | 1 |
| 7-Lateral Esquerda (551x388x15mm) | 7-Lado Izquierdo | 7-Left Side | 1 |
| 8-Divisão Pequena (268x150x15mm) | 8-Divisão Pequena | 8-Small Division | 2 |
| 9-Traseiro (1386x286x3mm) | 9-Trasero | 9-Back | 2 |
| 10-Porta Direita (544x432x15mm) | 10-Puerta Derecha | 10-Right Door | 1 |
| 11-Porta Esquerda (544x432x15mm) | 11-Puerta Izquierda | 11-Left Door | 1 |
| 12-Frente Gaveta (473x180x15mm) | 12-Cajón Frontal | 12-Drawer Front | 2 |
| 13-Traseiro Gaveta (454x105x15mm) | 13-Trasero del Cajón | 13-Drawer Back | 2 |
| 14-Lateral Gaveta (285x105x15mm) | 14-Lado del Cajón | 14-Drawer Side | 4 |
| 15-Fundo Gaveta (435x295x3mm) | 15-Fundo del Cajón | 15-Drawer Botton | 2 |

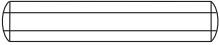
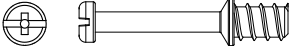
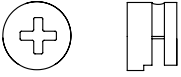

- O número na borda da peça corresponde ao manual.
- Para retirada do número usar Lustra-Móveis, Alcool em Gel ou Borracha.
- El número en el borde de la pieza coincide con el manual.
- Use una goma de borrar blanca, alcohol en gel o lustrador para muebles para eliminar los números.
- The number on the edge of the piece matches the manual.
- Use a White eraser, Alcohol Gel or Furniture Polish to remove the numbers.

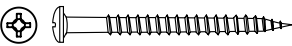
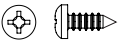
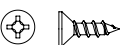
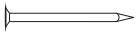
Lista de Materiais

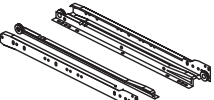
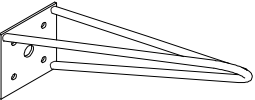
Lista de Materiales/ Hardware List

| | | | |
|----------|---|--|-----------|
| A |  | Cavilha / Tarugo / Dowel Ø6x30mm | 34 |
| B |  | Minifix / Minifix / Minifix Ø7x30mm | 17 |
| C |  | Tambor / Tambor / Minifix Cam Ø15x12mm | 17 |
| D |  | Tapa furo adesivo / Adhesivo / Hole Cover Ø18mm | 13 |
| E |  | Parafuso Tornillo / Screw Ø3,5x40mm CP | 06 |
| F |  | Parafuso Tornillo / Screw Ø4,0x14mm CP | 40 |
| G |  | Parafuso Tornillo / Screw Ø3,5x12mm CP | 16 |
| H |  | Prego Nail / Clavo 8x8 | 30 |
| I |  | Calço Dobradiça Cuna / Chock | 04 |
| J |  | Dobradiça Bisagra / Hinge | 04 |
| K |  | Corrediça Guia / Slider 350mm | 02 |
| L |  | Pé Metal Foot Metal / Pie de Metal | 06 |
| M |  | Prego Nail / Clavo 8x8 | 08 |

DICA PARA FIXAR MINIFIX

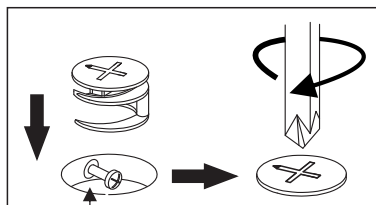

Cabeça do parafuso precisa estar no centro

Parafuso Minifix

Fixe o parafuso até o resalto encostar na superfície na peça. (veja o exemplo abaixo)

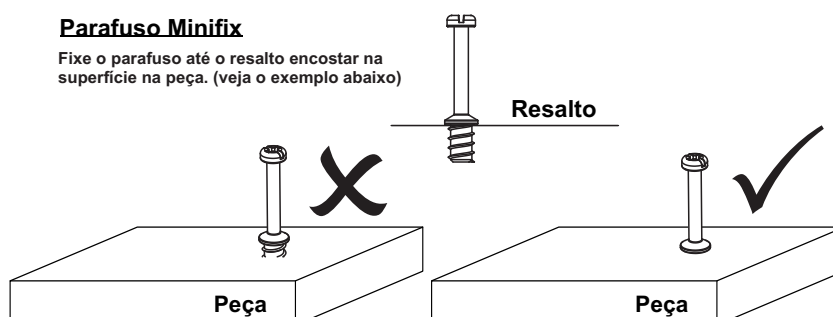

Passo 1

Paso/Step

PEÇA
Piece/Pieza

1 - TAMPO x1

FERRAGEM
Hardware/Herraje

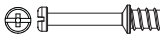
B  05

FERRAMENTA
Tool/Herramienta

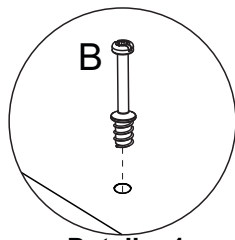
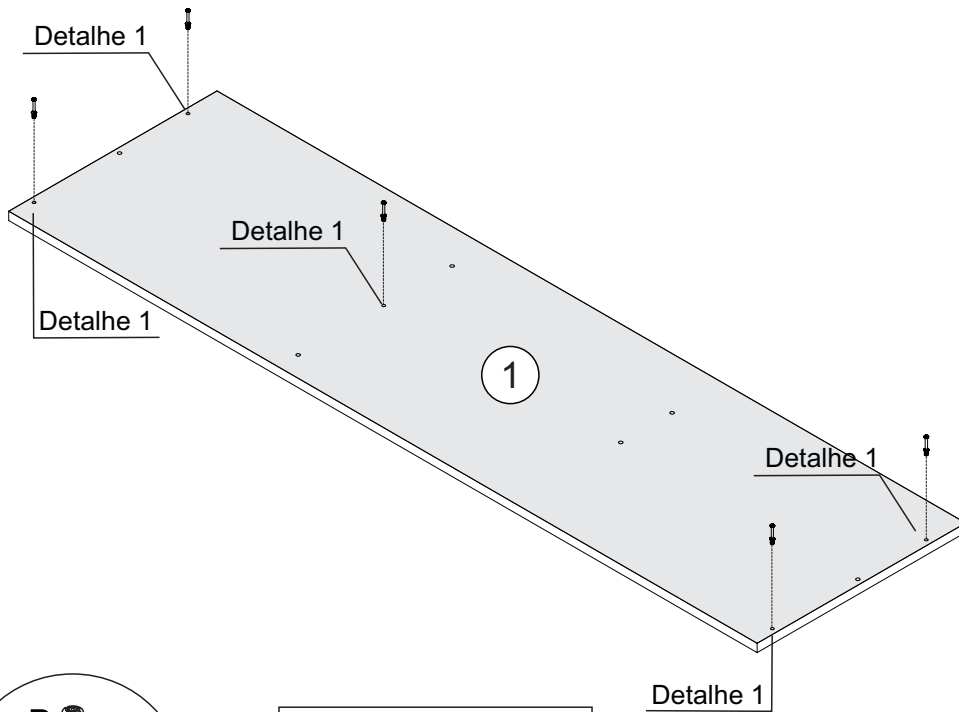
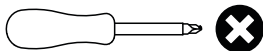

Detalhe 1
Detail/Detalle

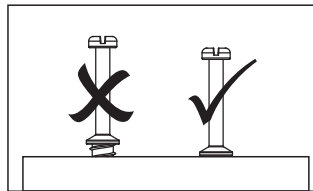

Passo 2

Paso/Step

PEÇA
Piece/Pieza

3 - PRATELEIRA GRANDE x1

FERRAGEM
Hardware/Herraje

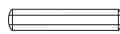
A  04

FERRAMENTA
Tool/Herramienta

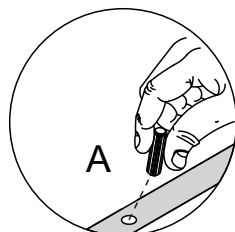
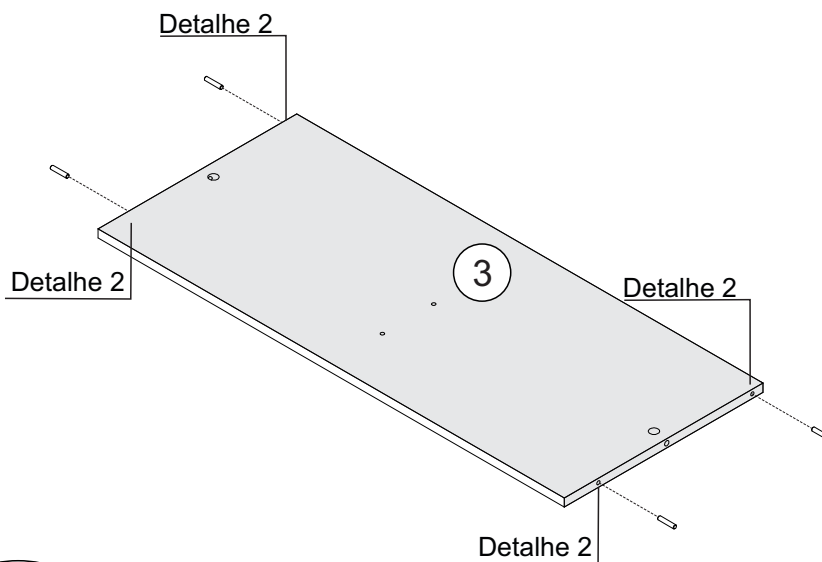
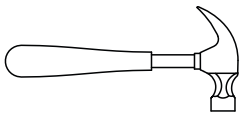

Detalhe 2
Detail/Detalle

Passo 3

Paso/Step

PEÇA
Piece/Pieza

4 - PRATELEIRA PEQUENA x1

FERRAGEM
Hardware/Herraje

A  04

FERRAMENTA
Tool/Herramienta

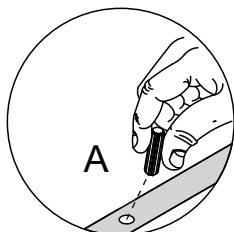
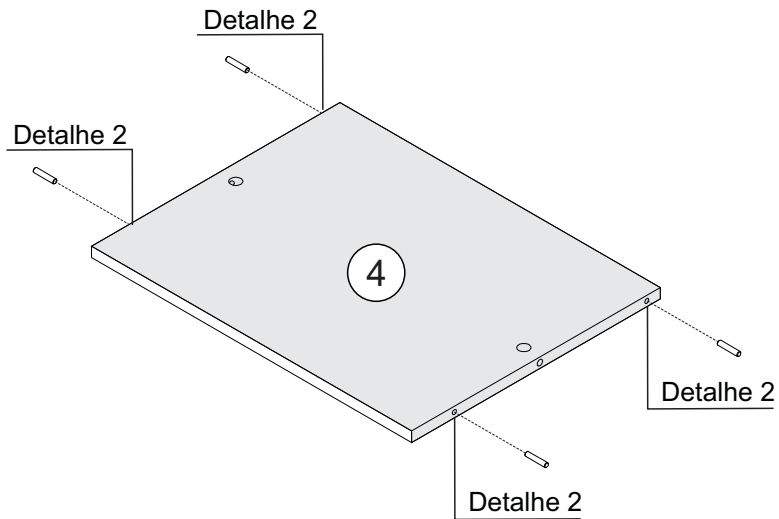
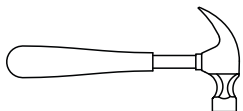

Detalhe 2
Detail/Detaille

Passo 4

Paso/Step

PEÇA
Piece/Pieza

7 - LATERAL ESQUERDA x1

FERRAGEM
Hardware/Herraje

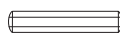
A  01

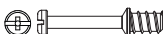
B  01

F  04

I  02

FERRAMENTA
Tool/Herramienta

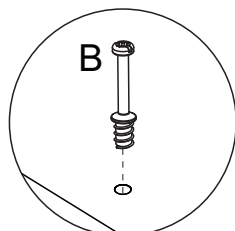
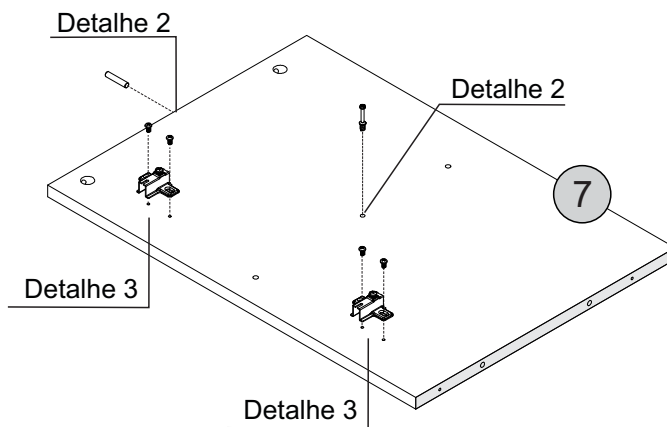
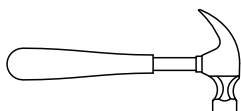
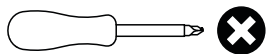

Detalhe 1
Detail/Detaille

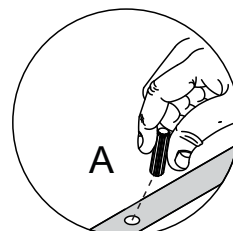

Detalhe 2
Detail/Detaille

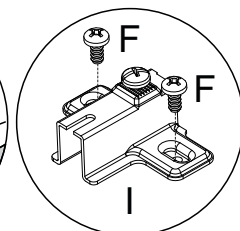

Detalhe 3
Detail/Detaille

Passo 5

Paso/Step

PEÇA
Piece/Pieza

6 - LATERAL DIREITA x1

FERRAGEM
Hardware/Herraje

A  01

B  01

G  04

K  02

FERRAMENTA
Tool/Herramienta

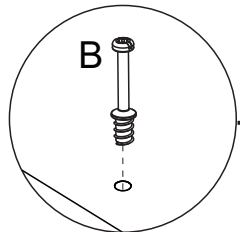
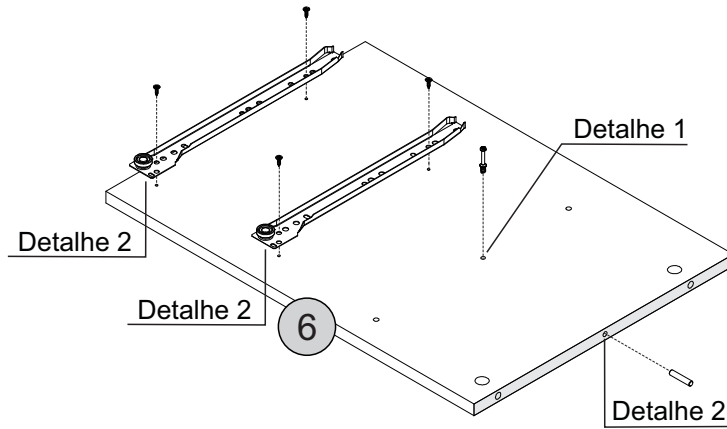
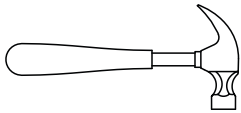
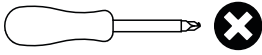

Detalhe 1
Detail/Detalle

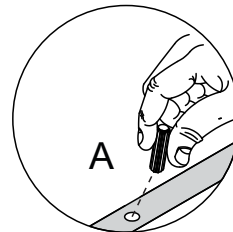
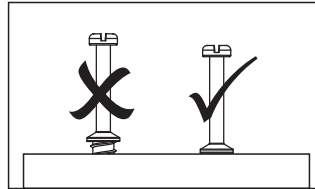

Detalhe 2
Detail/Detalle

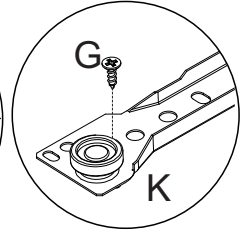

Detalhe 4
Detail/Detalle

Passo 6

Paso/Step

PEÇA
Piece/Pieza

9 - DIVISÃO x1

FERRAGEM
Hardware/Herraje

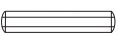
A  01

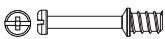
B  01

F  04

I  02

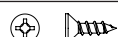
G  04

K  02

FERRAMENTA
Tool/Herramienta

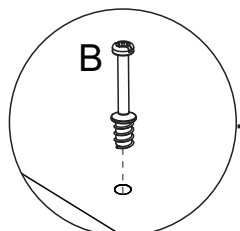
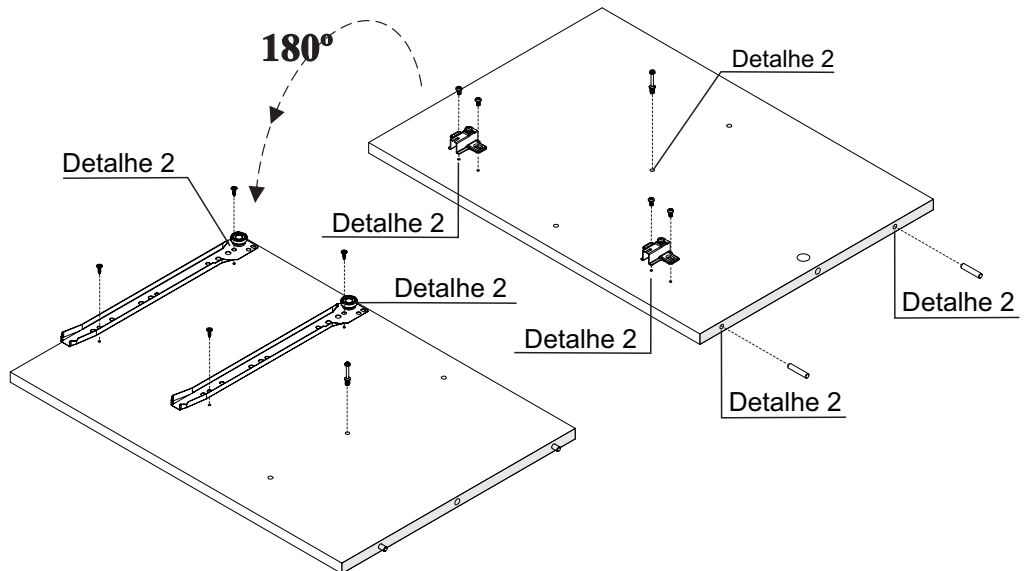
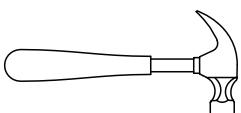
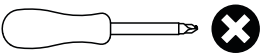

Detalhe 1
Detail/Detalle

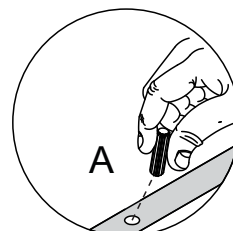
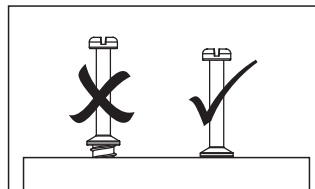

Detalhe 2
Detail/Detalle

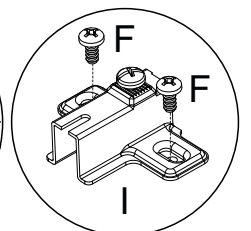

Detalhe 3
Detail/Detalle

Passo 7

Paso/Step

PEÇA
Piece/Pieza

7 - LATERAL ESQUERDA x1

3 - PRATELEIRA GRANDE x1

FERRAGEM
Hardware/Herraje

C   01

FERRAMENTA
Tool/Herramienta

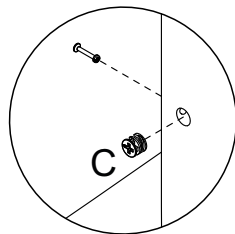
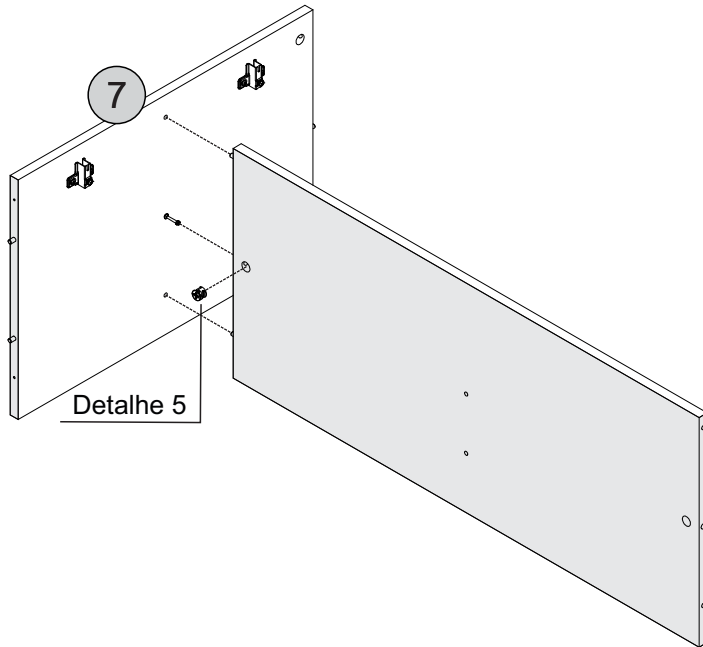
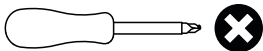

Detalhe 6
Detail/Detalle

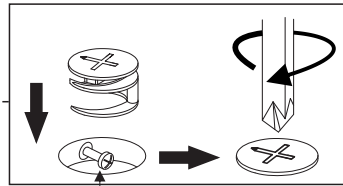

Cabeça do parafuso precisa estar no centro
La cabeza del tornillo debe estar en el centro
Screw head has to be in the center

Passo 8

Paso/Step

PEÇA
Piece/Pieza

9 - DIVISÃO x1

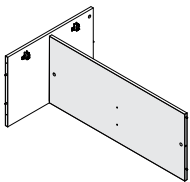

FERRAGEM
Hardware/Herraje

C   02

FERRAMENTA
Tool/Herramienta

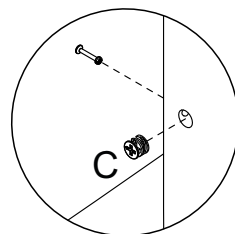
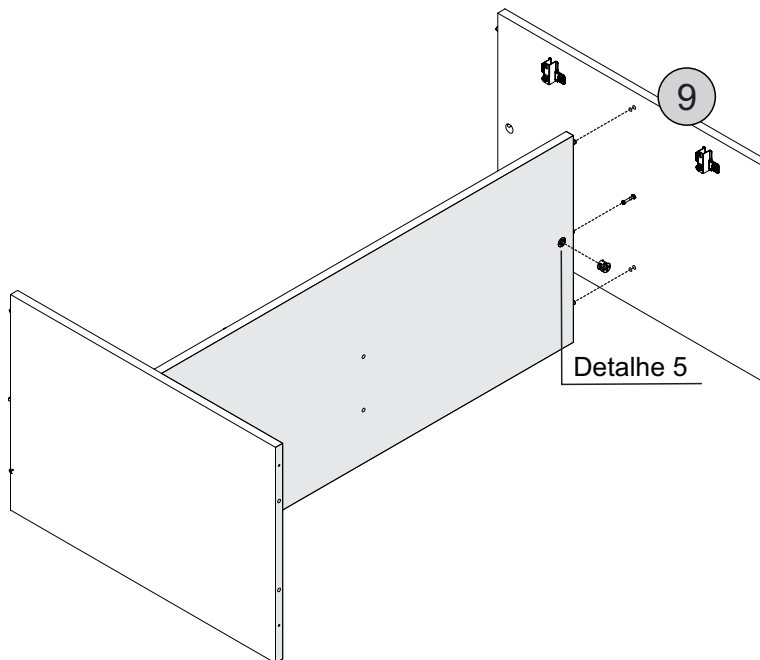
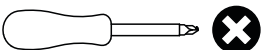

Detalhe 6
Detail/Detalle

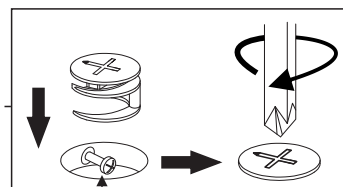

Cabeça do parafuso precisa estar no centro
La cabeza del tornillo debe estar en el centro
Screw head has to be in the center

Passo 9

Paso/Step

PEÇA

Piece/Pieza

4 - PRATELEIRA PEQUENA x1

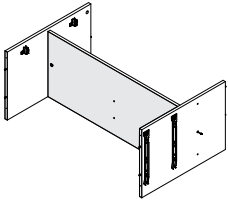

FERRAGEM

Hardware/Herraje



FERRAMENTA

Tool/Herramienta

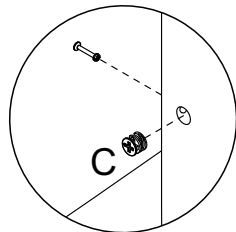
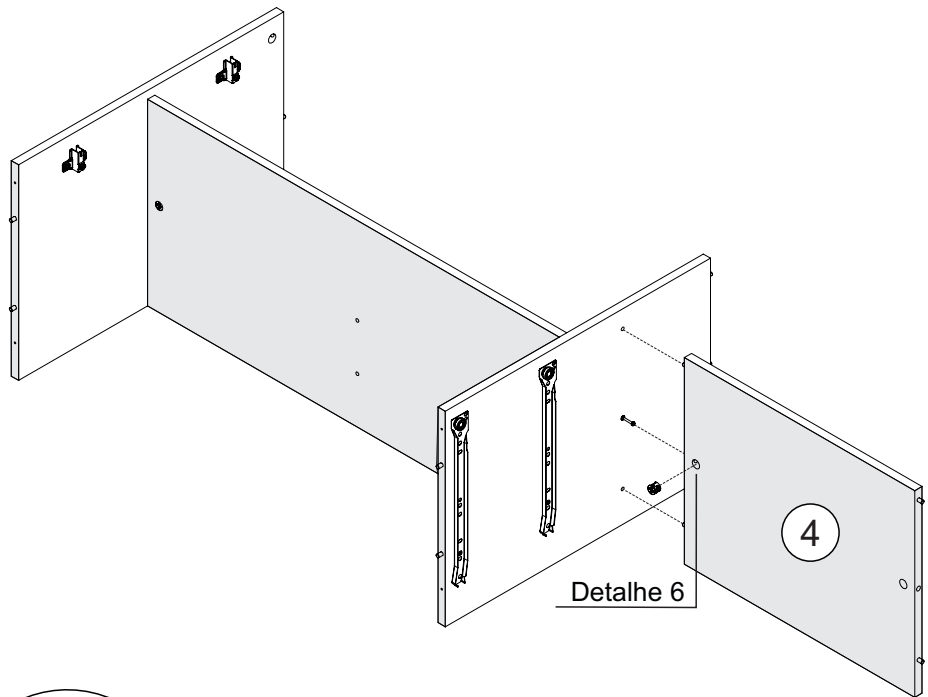
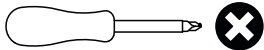

Detalhe 6
Detail/Detalle

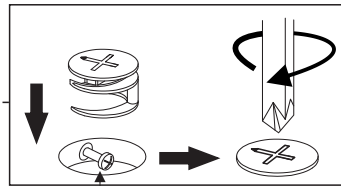

Cabeça do parafuso precisa estar no centro
La cabeza del tornillo debe estar en el centro
Screw head has to be in the center

Passo 10

Paso/Step

PEÇA

Piece/Pieza

6 - LATERAL DIREITA x1

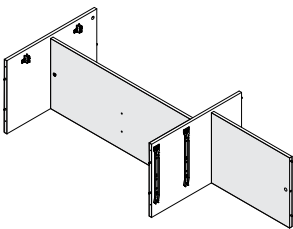

FERRAGEM

Hardware/Herraje

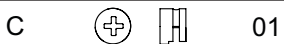

FERRAMENTA

Tool/Herramienta

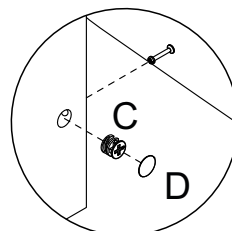
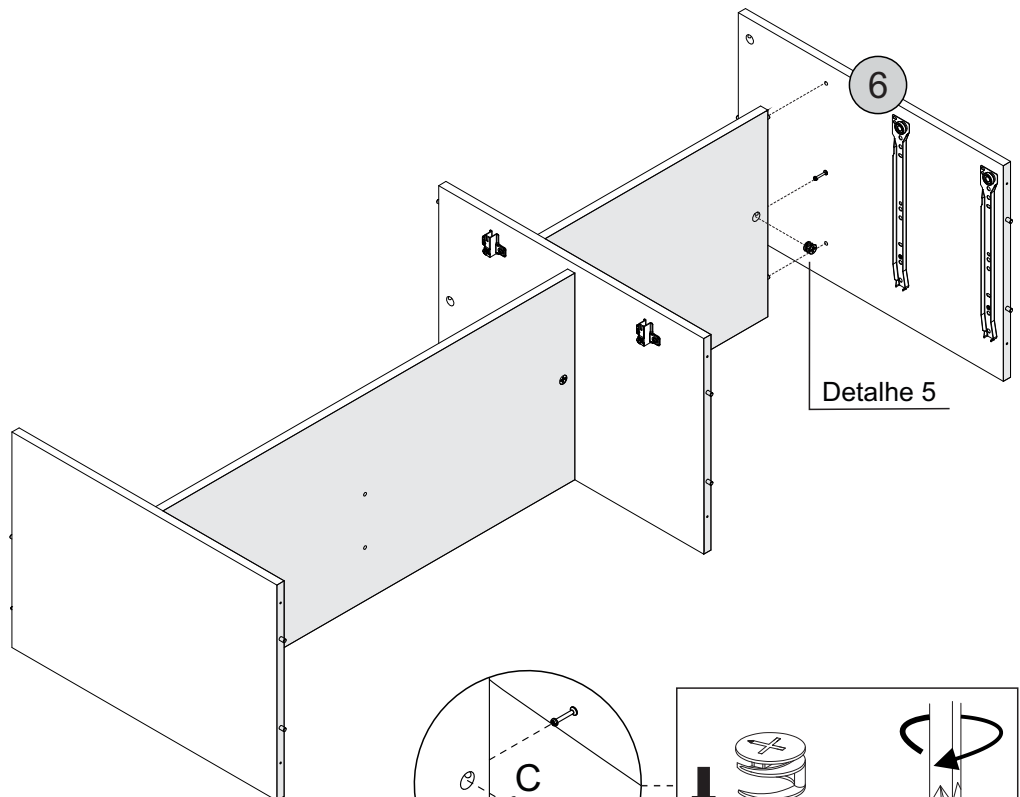
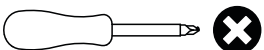

Detalhe 5
Detail/Detalle

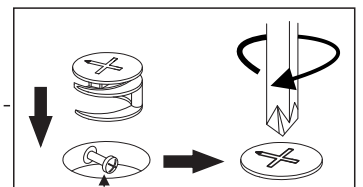

Cabeça do parafuso precisa estar no centro
La cabeza del tornillo debe estar en el centro
Screw head has to be in the center

Passo 11

Paso/Step

PEÇA

Piece/Pieza

8 - DIVISÃO PEQUENA x1

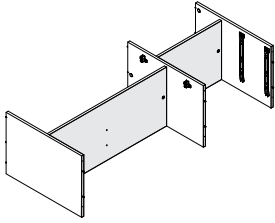

FERRAGEM

Hardware/Herraje

FERRAMENTA

Tool/Herramienta

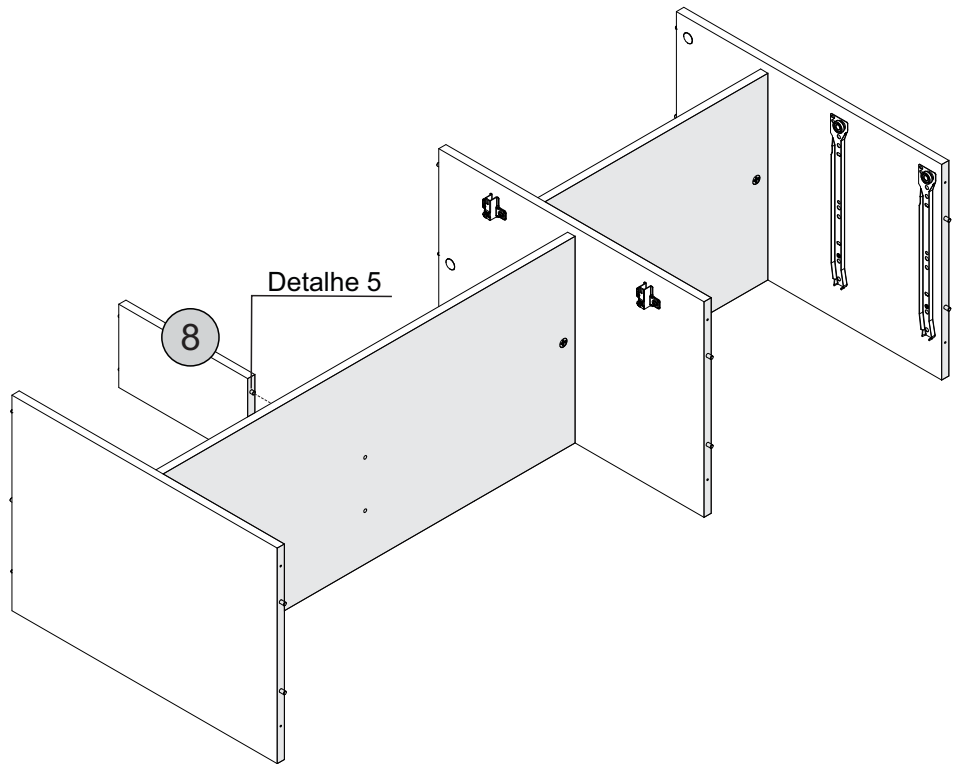

Passo 12

Paso/Step

PEÇA

Piece/Pieza

1 - TAMPO x1

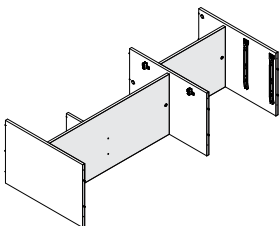

FERRAGEM

Hardware/Herraje

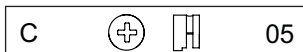

FERRAMENTA

Tool/Herramienta

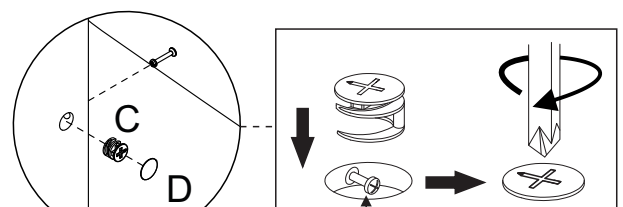
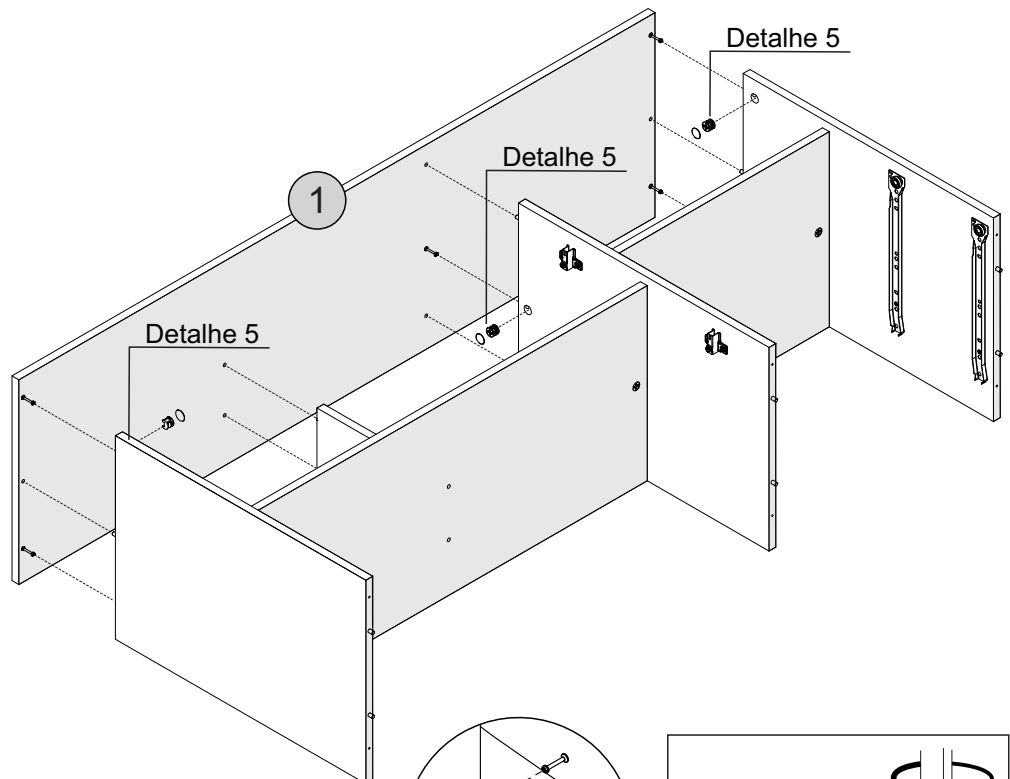
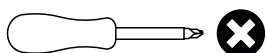

Detalhe 5
Detail/Detalle

Cabeça do parafuso precisa estar no centro
La cabeza del tornillo debe estar en el centro
Screw head has to be in the center

Passo 13

Paso/Step

PEÇA

Piece/Pieza

8 - DIVISÃO PEQUENA x1

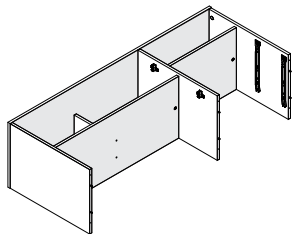

FERRAGEM

Hardware/Herraje

FERRAMENTA

Tool/Herramienta

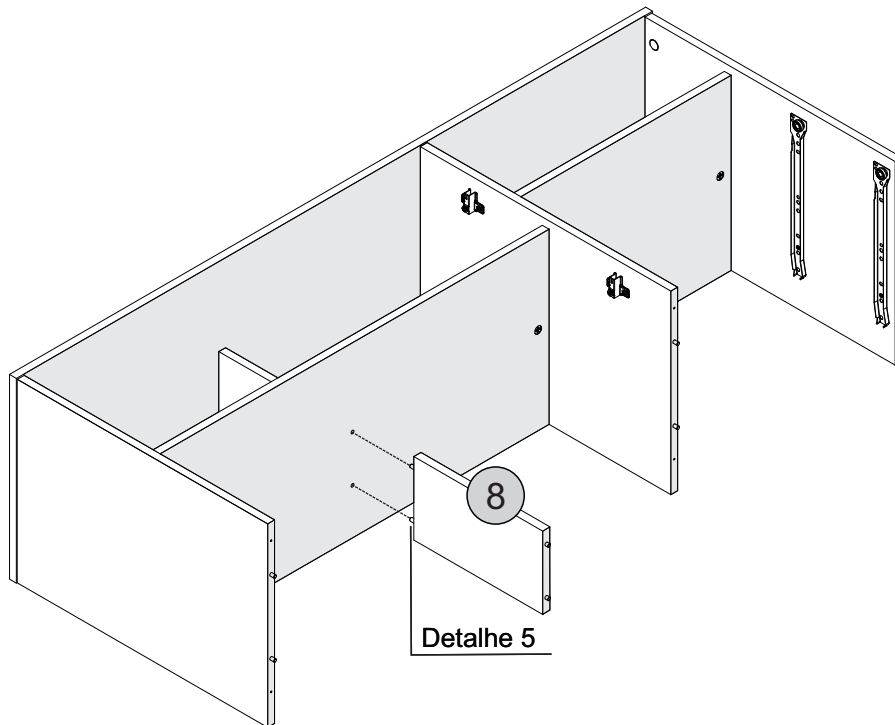

Passo 14

Paso/Step

PEÇA

Piece/Pieza

2 - BASE x1

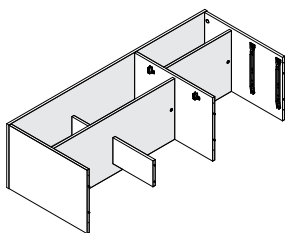

FERRAGEM

Hardware/Herraje

E  06

FERRAMENTA

Tool/Herramienta

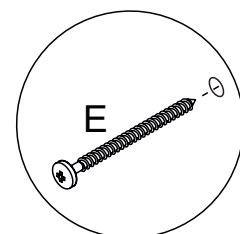
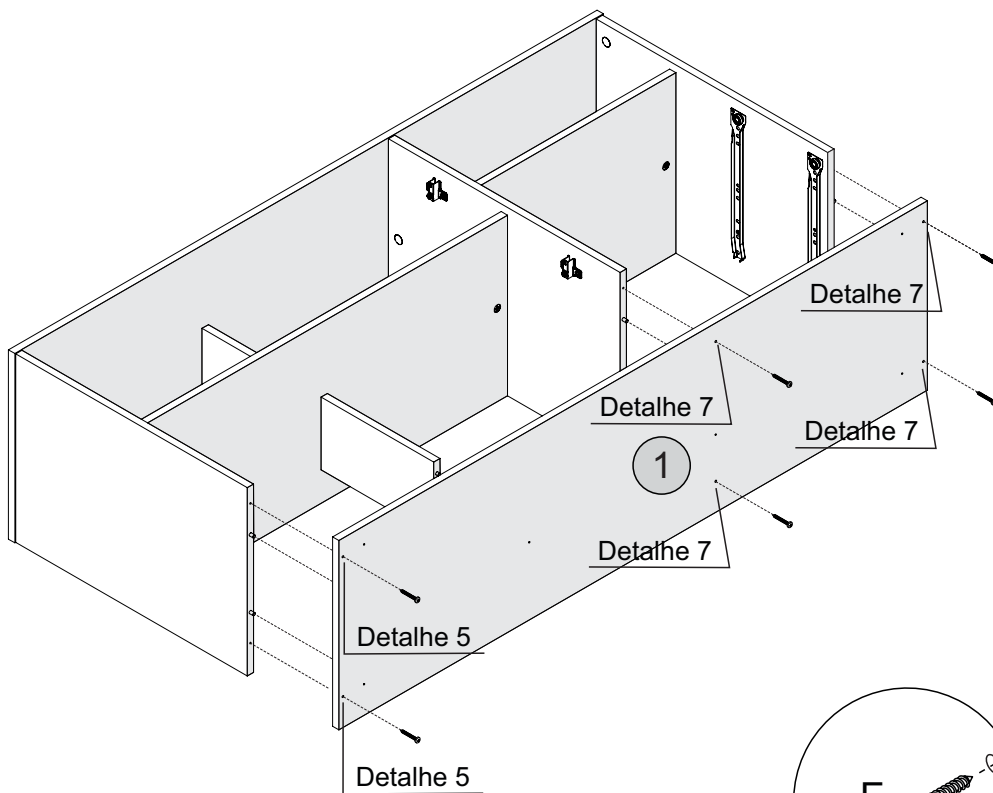
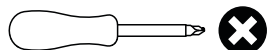

Detalhe 7
Detail/Detalle

Passo 15

Paso/Step

PEÇA
Piece/Pieza

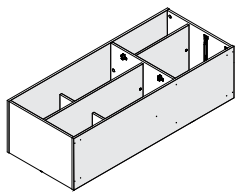

FERRAGEM
Hardware/Herraje

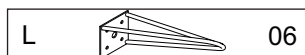
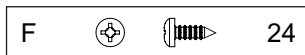

FERRAMENTA
Tool/Herramienta

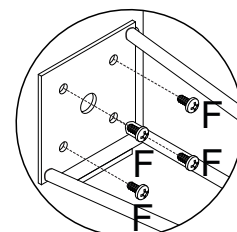
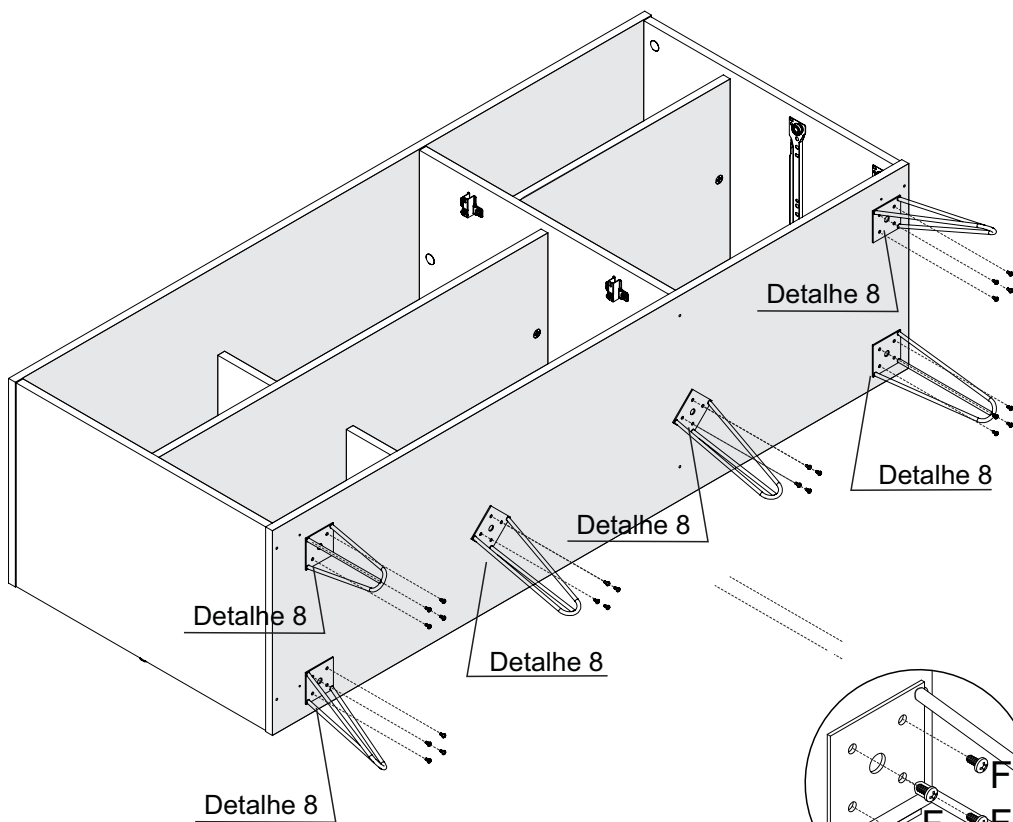
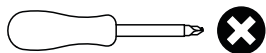

Detalhe 8
Detail/Detalle

Passo 16

Paso/Step

PEÇA
Piece/Pieza

16 - TRASEIRO x1

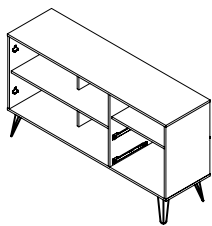

FERRAGEM
Hardware/Herraje

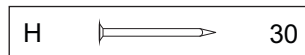

FERRAMENTA
Tool/Herramienta

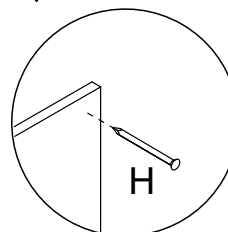
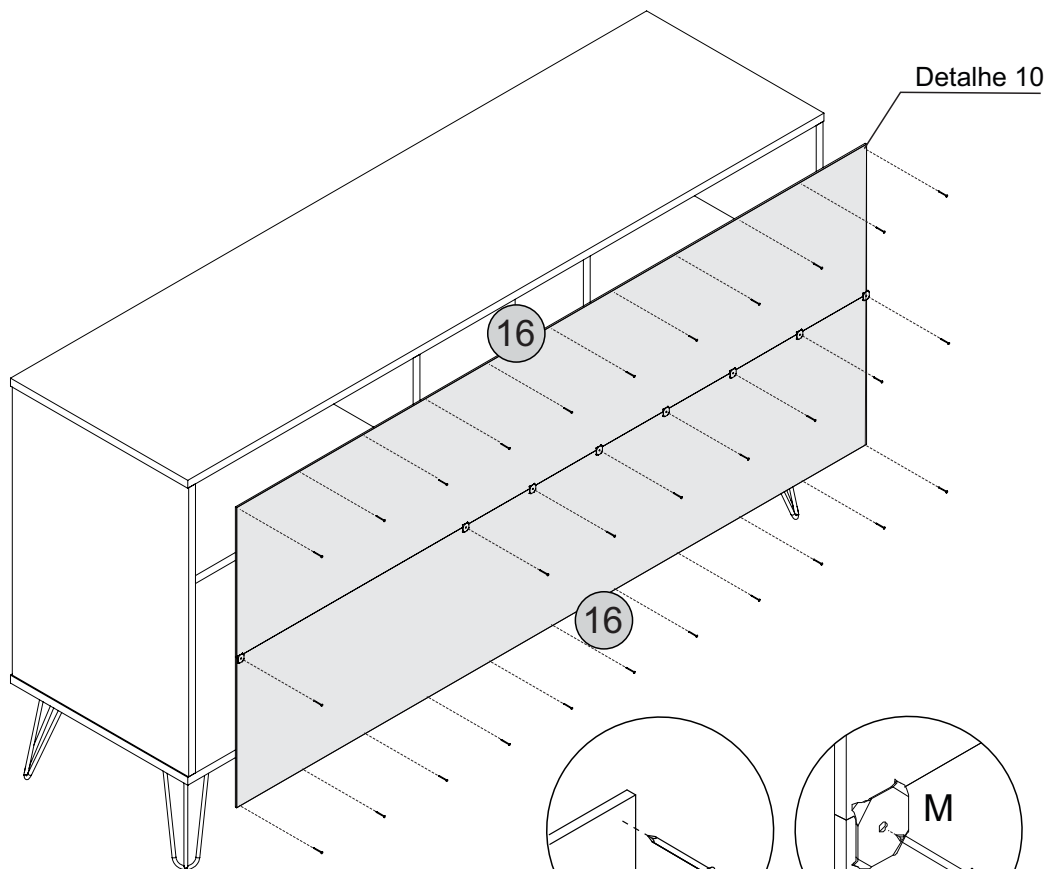
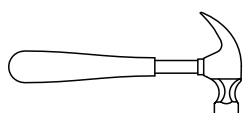

Detalhe 9
Detail/Detalle

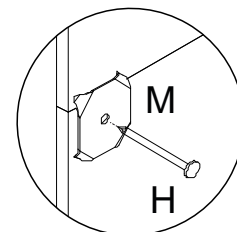

Detalhe 9
Detail/Detalle

Passo 17

Paso/Step

PEÇA

Piece/Pieza

9 - PORTA

x1

FERRAGEM

Hardware/Herraje

F



08

J



04

FERRAMENTA

Tool/Herramienta

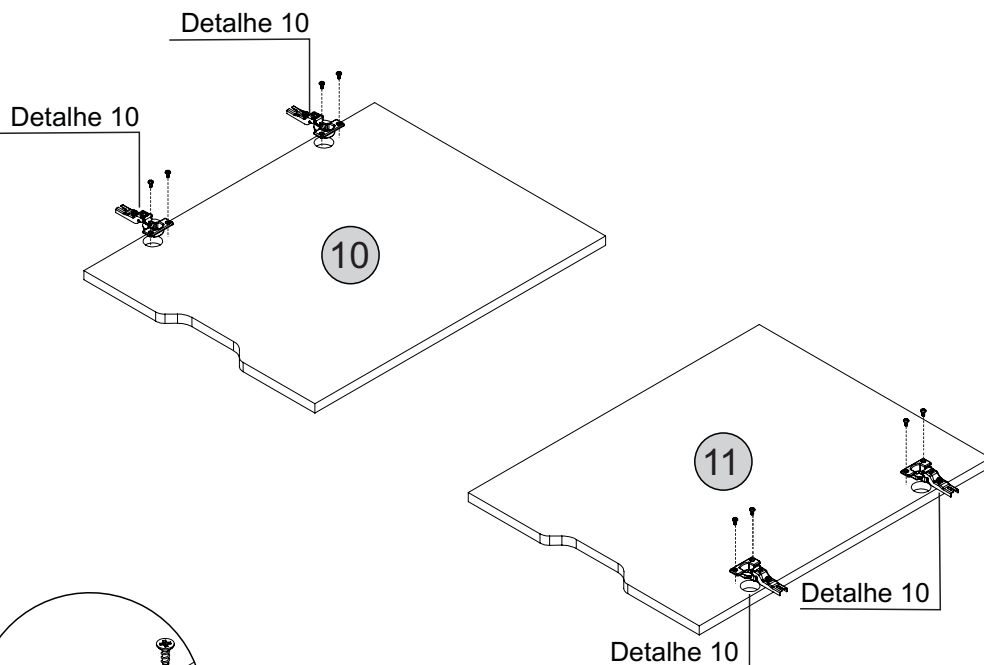
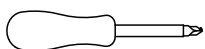

Detalhe 10
Detail/Detalle

Passo 18

Paso/Step

PEÇA

Piece/Pieza

9 - PORTA

x1

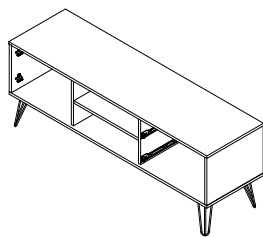

FERRAGEM

Hardware/Herraje

FERRAMENTA

Tool/Herramienta

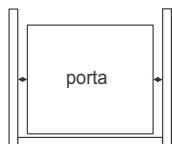
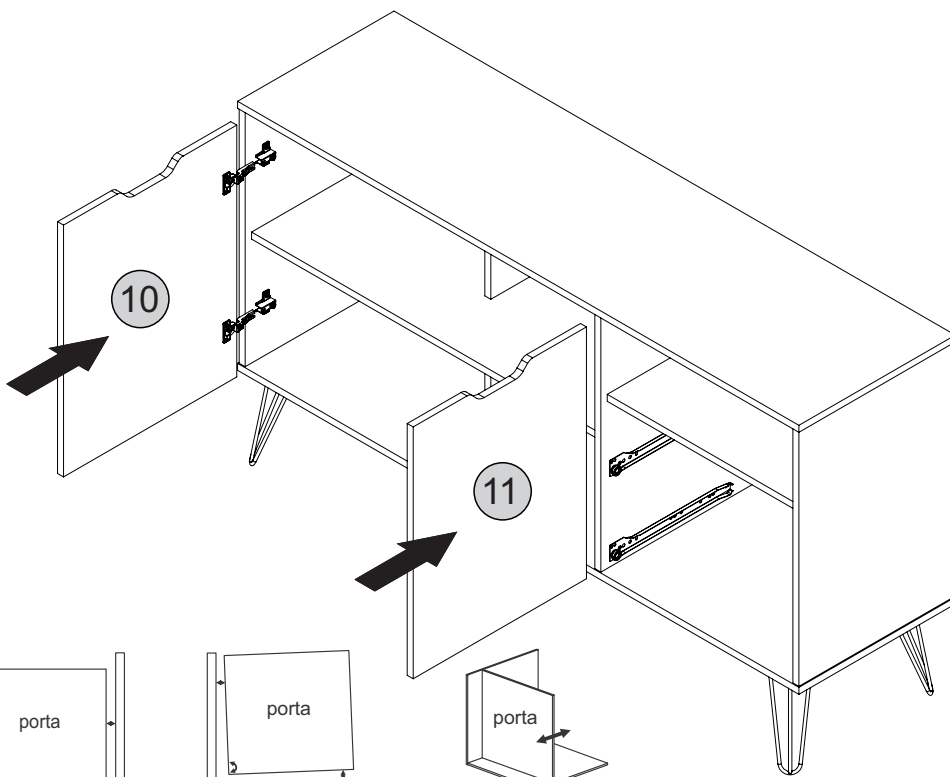
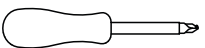

Ajuste de Largura

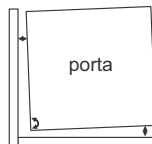

Ajuste Interno

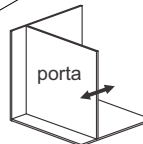

Ajuste de Profundidade

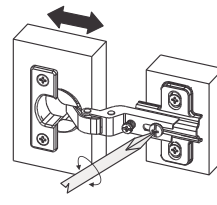
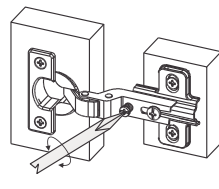
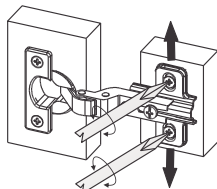

Passo 19

Paso/Step

PEÇA Piece/Pieza

10 - FRENTE GAVETA x2

12 - LATERAL GAVETA x4

FERRAGEM Hardware/Herraje

A  02

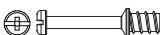
B  02

FERRAMENTA Tool/Herramienta

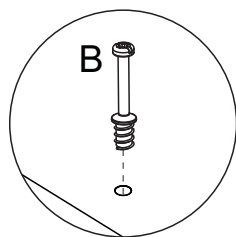
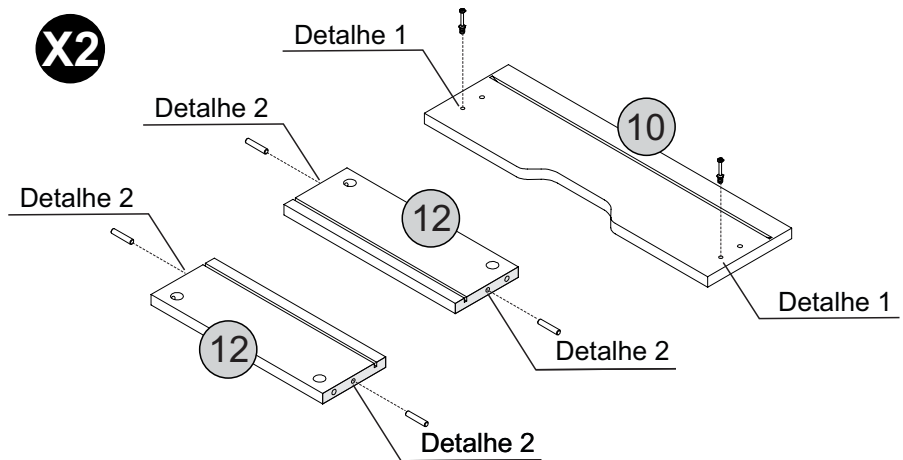
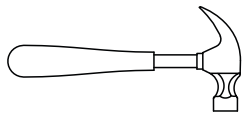
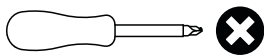

Detalhe 1
Detail/Detalle

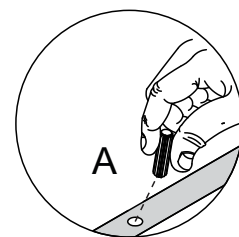
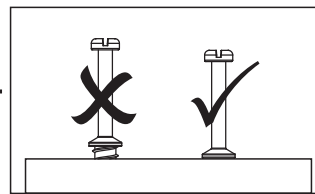

Detalhe 2
Detail/Detalle

Passo 20

Paso/Step

PEÇA Piece/Pieza

10 - FRENTE GAVETA x2

12 - LATERAL GAVETA x4

13 - FUNDO GAVETA x2

FERRAGEM Hardware/Herraje

C  02

D  02

FERRAMENTA Tool/Herramienta

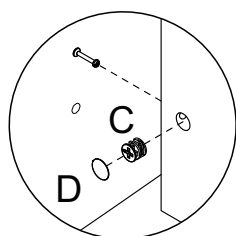
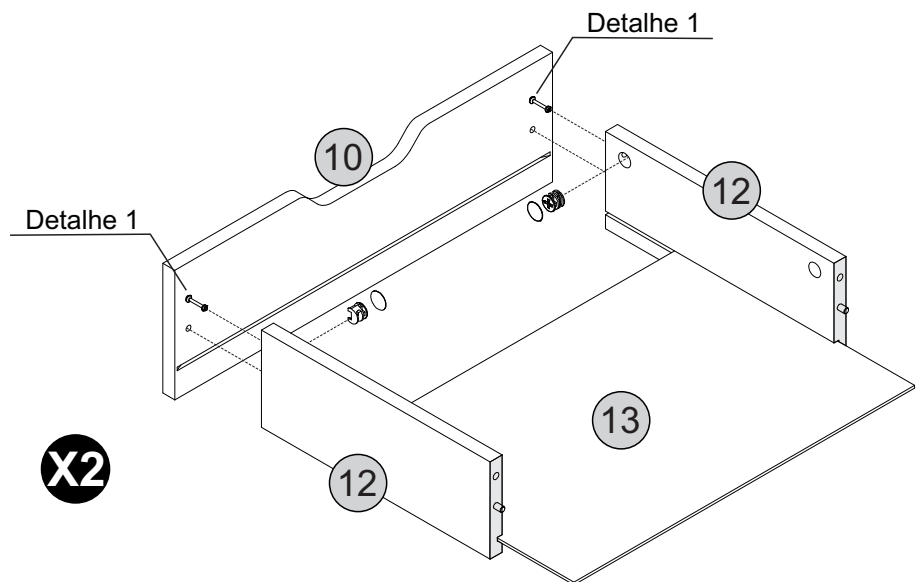
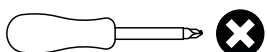

Detalhe 5
Detail/Detalle

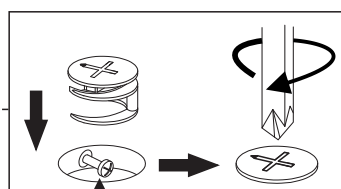

Cabeça do parafuso precisa estar no centro
La cabeza del tornillo debe estar en el centro
Screw head has to be in the center

Passo 21



Paso/Step

PEÇA
Pieça/Pieza

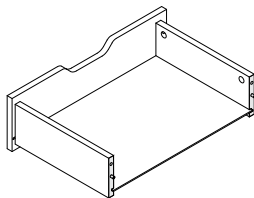
11 - TRASEIRO GAVETA x2



FERRAGEM
Hardware/Herraje

C   02

D  02

FERRAMENTA
Tool/Herramienta

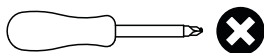

X2

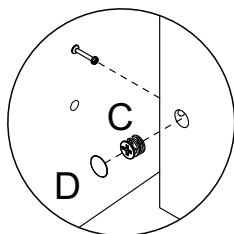
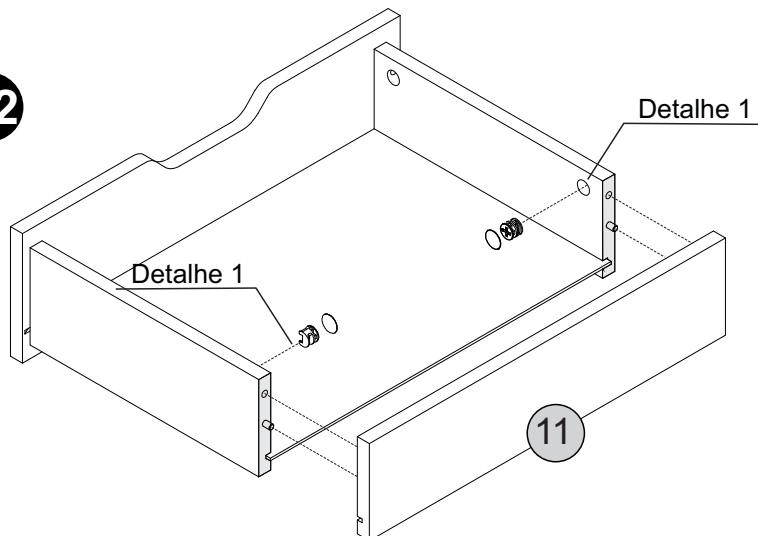

Detalhe 5
Detail/Detalle

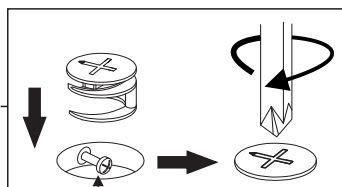

Cabeça do parafuso precisa estar no centro
La cabeza del tornillo debe estar en el centro
Screw head has to be in the center

Passo 22

Paso/Step

PEÇA
Pieça/Pieza

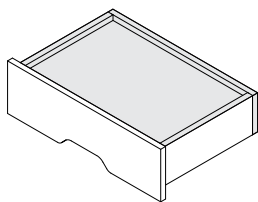

FERRAGEM
Hardware/Herraje

G   08

K  04

FERRAMENTA
Tool/Herramienta

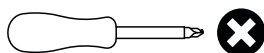

X2

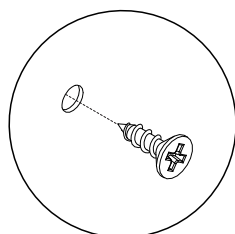
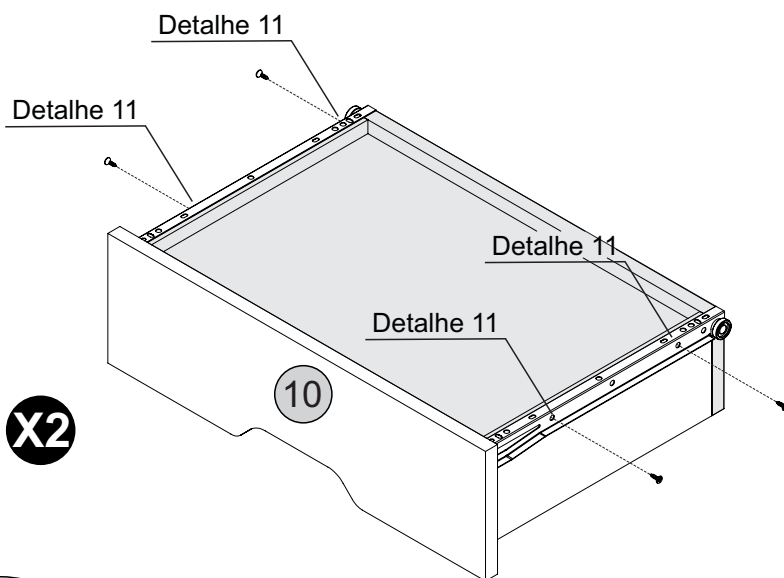

Detalhe 11
Detail/Detalle

Passo 23

Paso/Step

PEÇA
Pieze/Pieza

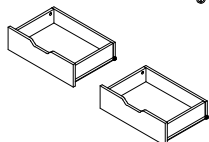
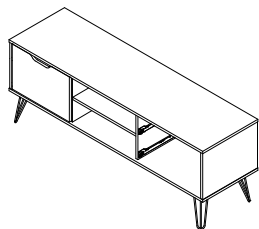

FERRAGEM
Hardware/Herraje

FERRAMENTA
Tool/Herramienta

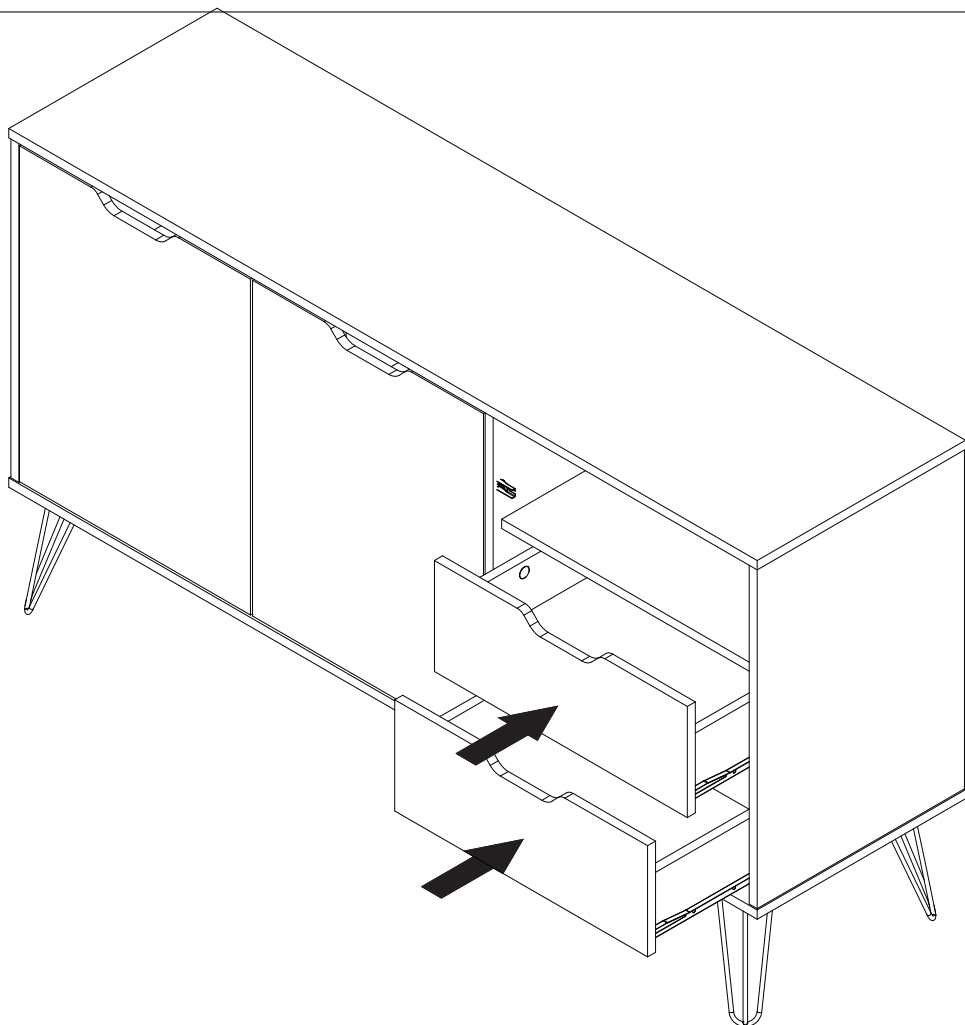
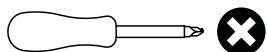

Passo 24

Paso/Step

PEÇA
Pieze/Pieza

FERRAGEM
Hardware/Herraje

FERRAMENTA
Tool/Herramienta



- O número na borda da peça corresponde ao manual.
- Para retirada do número usar Lustra-Móveis, Alcool em Gel ou Borracha.
- El número en el borde de la pieza coincide con el manual.
- Use una goma de borrar blanca, alcohol en gel o lustrador para muebles para eliminar los números.
- The number on the edge of the piece matches the manual.
- Use a White eraser, Alcohol Gel or Furniture Polish to remove the numbers.

